

# ENERGY MODELING FOR SUSTAINABLE BUILDINGS (2023)

Eduardo J. R. e S. Sampaio, Erondina A. Lima, Lenildo S. da Silva and Flavia M. de M. Santos

**Abstract**— The energy efficiency market is growing due to the need for reduced energy consumption and increased environmental awareness. These projects receive extensive support from industry professionals and society, aligning with sustainability and current project design trends. Prescriptive methodologies, equations, and simulations using computational tools are employed to understand consumer needs and propose efficient actions. However, project implementation faces challenges such as time constraints, high costs, and the need for specialized knowledge. To accurately assess and quantify the benefits, performance verification and energy modeling focused on sustainability are crucial. The *Palácio do Desenvolvimento* building in Brasília was studied as a case example. Measurements of energy consumption, analysis of construction and usage characteristics, validation of meteorological data, climate monitoring, and simulations were conducted. The results provided valuable insights for developing efficient and sustainable strategies. The simulation accurately reflected the building's energy performance, and operational data contributed to precise analysis. Comparing measured and national climatic data validated the representativeness of the local environment. The climatic data used in the simulator exhibited behavior similar to national data, enhancing the simulations' reliability. Consistency and similarity among the results highlight the robustness of the analyses and reinforce the validity of the conclusions. These findings contribute to efficient strategies for the *Palácio do*

*Desenvolvimento* building and similar projects in the future. By addressing the challenges and employing accurate assessment techniques, energy efficiency projects can effectively reduce energy consumption and promote sustainability.

**Index Terms**— Climate monitoring, Computational tools, Construction characteristics, Energy consumption, Energy efficiency, Environmental awareness, Measurements, Operational data, Performance verification, Prescriptive methodologies, Project design, Simulations, Sustainability, Validation of data.

## I. INTRODUCTION

THE world has been demanding processes of restructuring and reframing analytical parameters and project scopes increasingly focused on optimization, cost-cutting, and the provision of more efficient services and products. The United Nations' Agenda 2030 Report [1] presents various proposals, including one outlined in Sustainable Cities and Communities Goal 11, which aims to "make cities and human settlements inclusive, safe, resilient, and sustainable." This goal encourages the sustainability of cities and communities and the provision of clean and accessible energy, with the objective of reducing the environmental impact generated by global energy consumption.

The growth of large urban centers and their transformations significantly alter and impact the functioning and energy consumption of regions. This situation leads to cases of environmental degradation and sparks debates on how society will make continuous development viable, as well as how each region of the planet, with its specific market characteristics, economy, and population, will be responsible for climate change that directly affects the current changes [2].

According to the PROCEL's results report (2022), 22.73 billion kWh were saved through the promotion of efficient electricity use and waste reduction in 2021. Therefore, considering this significant growth in energy efficiency initiatives, there is a need to understand how the continuous alteration of the built environment impacts local energy consumption [3].

Most energy consumption is attributed to the need for indoor environment adaptation through artificial lighting and air conditioning systems, which are well-known end-

This paragraph of the first footnote will contain the date on which you submitted your paper for review, which is populated by IEEE. It is IEEE style to display support information, including sponsor and financial support acknowledgment, here and not in an acknowledgment section at the end of the article. For example, "This work was supported in part by the U.S. Department of Commerce under Grant 123456." The name of the corresponding author appears after the financial information, e.g. (*Corresponding author: Second B. Author*). Here you may also indicate if authors contributed equally or if there are co-first authors.

The next few paragraphs should contain the authors' current affiliations, including current address and e-mail. For example, First A. Author is with the National Institute of Standards and Technology, Boulder, CO 80305 USA (e-mail: author@boulder.nist.gov).

Second B. Author Jr. was with Rice University, Houston, TX 77005 USA. He is now with the Department of Physics, Colorado State University, Fort Collins, CO 80523 USA (e-mail: author@lamar.colostate.edu).

Third C. Author is with the Electrical Engineering Department, University of Colorado, Boulder, CO 80309 USA, on leave from the National Research Institute for Metals, Tsukuba 305-0047, Japan (e-mail: author@nrim.go.jp).

Mentions of supplemental materials and animal/human rights statements can be included here.

Color versions of one or more of the figures in this article are available online at <http://ieeexplore.ieee.org>

uses of energy and are typically addressed through simple equipment upgrades [4]. The consumption and revenue report by ANEEL [5] reveals that 73% of energy consumed in 2019 can be classified into the following categories: residential, public sector, commercial, and services.

The environmental impact and energy costs of buildings in operation worldwide have followed a pattern of indiscriminate replication since the second half of the 20th century. This change has resulted in numerous examples of occupant discomfort and health problems, which prompted the emergence of new architectural and environmental performance paradigms in the early 1990s [6]. New models were established, aiming to reduce energy demand and improve social dynamics and environmental quality through architectural responses proposed by designers at the time.

Emmanuel [7] contributes by demonstrating the importance of valuing current architectural opportunities related to environmental conditioning and thermal comfort in buildings within the context of energy efficiency. According to him, operations of buildings constructed in tropical regions must undergo proper thermal modeling, as the geographical positioning of these cities leads to excessive energy consumption from air conditioning units.

In order to achieve proper energy consumption reduction in an efficient and optimized manner, the integration of natural and artificial systems is necessary [8]. There is a demand for projects that harness air movement and utilize internal airflow within buildings, where architectural design becomes a factor in reducing reliance on electrically powered air conditioning systems [8]. Lee [9], former Prime Minister of Singapore, supports this idea by emphasizing the importance of thermal comfort opportunities in tropical cities. He states that "thanks to air conditioning, there has been a change in the nature of civilization, enabling work in the tropics," highlighting the significance of addressing this issue due to the increasing electricity consumption in tropical countries.

Another aspect, related to lighting methods, recognizes that beyond simply utilizing controlled daylighting as a methodology to reduce electrical energy consumption, the use of sunlight is crucial for "comfort and health." Sunlight provides clean energy free from harmful elements associated with environmentally damaging power generation systems [10]. It is also mentioned that in situations where natural lighting is not feasible, a preliminary observation study should be conducted to identify available solutions. The choice of artificial lighting should be optimized appropriately through lighting design projects, ensuring clarity, quality of light, and color rendering indexes compatible with the necessary requirements using the most advanced technologies that guarantee the required luminous

efficiency.

Government programs worldwide aim to promote the implementation and intensification of technological and industrial development in the photovoltaic energy and energy efficiency markets [11]. When translating this idea to the Brazilian context, notable incentive programs include Research and Development (P&D) and Energy Efficiency Projects (PEE), regulated by the National Electric Energy Agency (ANEEL). These programs were established by Law No. 9.991, dated July 24, 2000 [12], which mandates that electricity distribution companies allocate 0.5% of their net operating revenue to energy efficiency projects (PEE) and another 0.5% to research and development (P&D). Another example of incentives for energy efficiency projects is related to energy consumption optimization in buildings. It is linked to the PROCEL Edifica program, with guidelines and criteria for compliance evaluation outlined in Ordinance No. 372/2010 [13], based on the Technical Quality Regulations for Energy Efficiency Levels in Buildings (RTQ-C for Commercial, Service, and Public Buildings, and RTQ-R for Residential Buildings). Part of these incentives and investment burdens can provide opportunities for resource acquisition for architecturally energy-efficient projects, which can be analyzed within the methodology of evaluation for this paper.

The pursuit of these means has been promoting the ANEEL's Energy Efficiency Projects (PEE), which include funding announcements within their scope, offering sources of resources for the energy efficiency improvement of various types of consumer units. The funds are provided by the energy distribution companies, which manage and monitor the progress of the projects. The proponents are responsible for proposing the energy efficiency actions (AEE) to be carried out. Guidelines are proposed to provide standardization and systematization of the PEE [14]. In addition to the knowledge and financial incentives, technological advancements have also played a crucial role. Computational simulations facilitate evaluations but are not commonly associated with the projects proposed by these proponents [15].

Another important point is that the COVID-19 pandemic has had a significant impact on the use of commercial buildings and government facilities worldwide. Governments have taken necessary actions to reduce the spread of the coronavirus, including social distancing measures. With the closure of offices and stores to contain the virus, many buildings were left vacant. Many companies and individuals opted to work and shop online, reducing the need for physical space [16]. As a result, many buildings remained empty, leading to a steep decline in electricity consumption. Moreover, with more people working and studying from home, there was a reduced demand for air conditioning and lighting in offices and schools. This resulted in reduced energy operating costs for buildings [17].

In this work, topics reflecting the aforementioned points will be addressed through reflections and analyses conducted at the *Palácio do Desenvolvimento* building, located in Brasília, Federal District, Brazil. The building has undergone various renovation actions since its construction. From there, the idea emerged to propose some actions for the energy efficiency improvement of public buildings. The building, which also serves as the headquarters of INCRA, serves as a practical case for the research and contextualizes the justification for certain activities used to address energy inefficiency in office buildings. Therefore, it presents an opportunity to verify how a step-by-step approach to proposing energy efficiency actions can bring ease and time reduction throughout the different stages of the project.

In this regard, it is envisioned that there is an opportunity to demonstrate how energy efficiency actions can be proposed, not limited to the installation of LED lighting systems, which is commonly implemented due to its practicality and relatively low cost. There is room here for the incorporation of actions aimed at the building envelope and incentivized sources of energy generation [18]. Studies show that there is a demand for new parameters for analysis in energy efficiency projects [19]. Proposals are exemplified where not only actions related to the final use of electrical energy are considered, such as simple replacements, but also the outcomes of actions focused on the building envelope and sustainable generation projects.

Triana and Lamberts [20] brought forth proposals for the inclusion of strategies to improve thermal performance and rational use of energy. Computational simulations used for verification and validation of strategies that optimize the building envelope are essential for the performance of a space. Therefore, in these examples, opportunities can be seen across a broad spectrum of electricity consumption and production, where assessments can be conducted to enable more analytical projects that are better tailored to the needs of the consumer.

The main goal of this paper was to model the energy consumption of a building and analyze how the incorporation of energy efficiency actions can influence its performance. Some of the Specific were:

- a. Define the key parameters for data collection and information gathering to provide the foundation for better planning, implementation, and future monitoring of the project.
- b. Demonstrate, through a real case study, how the planning and organization of information within an energy efficiency project can impact the quality of the project.
- c. Analyze the influence of energy efficiency actions related to the selection of materials to be implemented in the project (such as window glass and generation equipment).

- d. Propose actions for the energy efficiency improvement of a building based on local climatic characteristics that have been identified and presented.

II. LITERATURE REVIEW

This chapter discusses the main concepts used in the research, serving as a foundation for the topics discussed throughout the text. It covers thematic areas related to the design processes that range from the formatting and standardization of an energy efficiency project to data collection stages and computer simulations.

A. Normalization of energy efficiency projects and simulations

Through Ordinance No. 372, dated September 17, 2010 [13], the president of the National Institute of Metrology, Standardization, and Industrial Quality (INMETRO) approved the Technical Requirements for the Energy Efficiency Level of Commercial, Service, and Public Buildings (RTQ). Its objective is transcribed in its entirety within the annexes of the ordinance: "To create conditions for labeling the energy efficiency level of commercial, service, and public buildings."

Within this context, it is expected that the process that validates an energy efficiency project includes labeling. Part of the procedure involves evaluating three aspects: building envelope, lighting system, and air conditioning system. All of these aspects are part of the evaluation in the Brazilian Building Labeling Program (PBE Edifica) and comply with the National Energy Conservation Labeling System (ENCE), which ranges from the highest efficiency level A to the lowest efficiency level E (Figure 1). The norm also states that: "The energy efficiency labeling of buildings should be carried out through prescriptive methods or simulation."

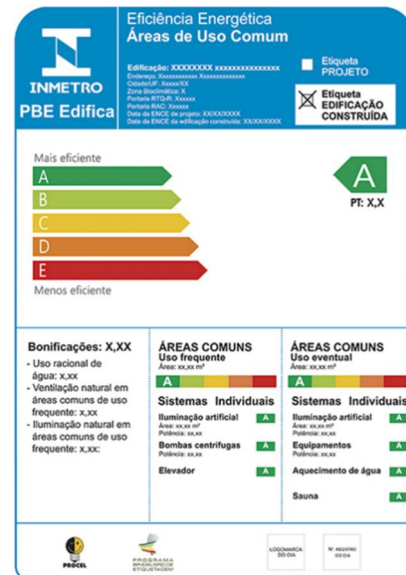


Fig. 1. The ENCE label.[13]

The standard establishes two forms of certification for energy efficiency labeling of buildings. One is the prescriptive method, and the other is the simulation method. Carlo and Lamberts [21] define that: "The prescriptive method consists of a series of predefined or calculated parameters that indicate the system's efficiency, while the simulation method determines parameters for modeling and simulation but allows for more flexibility in building design."

Some combinations of these methods are presented in the RTQ-C (Table 1) and are used in the ENCE labeling process. Each of these partial building systems is classified according to the following weights: envelope with 30%, lighting system with 30%, and air conditioning system with 40%.

TABLE I  
COMBINATIONS OF EVALUATION METHODS FOR ENCE PBE  
EDIFICA CERTIFICATION

Envelope	Lighting System	Air Conditioning System	Natural Ventilation
Prescriptive Method	Prescriptive Method	Prescriptive Method	Simulation Method
Simulation Method	Simulation Method	Simulation Method	Simulation Method
Simulation Method	Prescriptive Method	Prescriptive Method	Simulation Method

One fundamental regulation that supports procedures used in a prescriptive method for the energy efficiency process is Law No. 9.991 [12], which obligates electricity distribution companies to allocate 0.5% of their net operating revenue to energy efficiency projects (PEE) and another 0.5% to research and development (R&D). The search for these resources has been fostering PEE projects by ANEEL (Brazilian Electricity Regulatory Agency), which includes funding announcements offering sources of funding for the energy efficiency of consumer units of various types. The funds are provided by the energy distributors, who manage and monitor the progress of the projects. The proponents are responsible for proposing the energy efficiency actions (AEE) to be carried out. These proponents must strictly adhere to the Procedures of the Energy Efficiency Program (PROPEE) [18].

PROPEE discusses a way to measure the consumption of lighting and environmental conditioning systems. The equations are listed as follows, starting with the calculation for lighting systems (Equation 1).

$$\sum E_{a_i} = \frac{(q_{a_i} \times p_{a_i} \times h_{a_i})}{1e6} \text{ MWH/yr (1)}$$

Where:

- $q_a$  is the quantity of equipment involved in the study;
- $p_a$  is the power specified by the equipment manual given in Watts (W);
- $h_a$  is the operating time of the equipment over

a year calculated by the hours, days, and weeks they are turned on.

The environmental conditioning system is described by the following equation (Equation 2).

$$\sum E_{a_i} = \frac{(q_{a_i} \times p_{a_i} \times 0.293 \times h_{a_i} \times FU)}{1e6 \times ca_i} \text{ MWH/yr (2)}$$

Where:

- $q_a$  is the quantity of equipment involved in the study;
- $p_a$  is the cooling capacity specified by the equipment manual given in BTU per hour;
- 0.293 is the conversion coefficient from BTU/h to Watts;
- $ca$  is the coefficient of performance (COP) that represents how much energy from the grid is being used to generate the specified cooling capacity;
- $h_a$  is the operating time of the equipment over a year, calculated by the hours, days, and weeks they are turned on;
- $FU$  is the utilization factor.

On the other hand, Venâncio [22] contributes in his thesis by stating that the use of computational tools, as part of a project, tends to facilitate decision-making through simulation. With a well-informed decision, there is greater assurance of a building's performance. In other words, by correctly parameterizing tools and models in simulations, higher performance values can be achieved. Gabriel [23] warns that tools such as EnergyPlus or DesignBuilder are accepted by the RTQ of PROCEL as computational tools.

These standards and legislated regulations are fundamental to the process of developing a project. They ensure that the building is safe, reliable, and of high quality by establishing specific criteria for the building's performance, using equipment and materials that meet satisfactory levels of safety and comfort, guaranteeing efficiency levels throughout the project's lifespan.

### B. Project Process

The reflection on sustainable design practices was prompted by environmental movements [24]. These reflections began by demonstrating how the evolution of sustainability resulted from a cumulative effect that converged towards the need for a better environmental awareness focused on the world as a communal and common environment. To achieve this, the evolution traced the movements defined and originated by the people, meaning by a society that envisioned the need for new interactions and renewal habits for society to endure for a longer time. Encompassing the idea of sustainable design as something that requires a process, O'Brien's work [2] provides strategies on how technical demands should be structured and what tools, resolutions, and presentation methods should be used to convey the envisioned ideas. According to him, the project should



start with the preparation of information, organization of collected data (budgeting, occupancy levels, and building usage expectations), followed by the design concept.

Kwok and Grondzik [25] outline a step-by-step approach for actions related to the design process. However, they emphasize the importance of identifying the problem to be addressed. This definition is composed of conceptualization, solution intent, criteria organization, and validation, involving the ability to adjust and prioritize as necessary. Based on these evaluations, priorities are established, achievable goals are set within a specified timeframe. Borgstein et al. [26] structure some of the stages of this step-by-step approach and relate them to the evaluation process of energy performance in commercial buildings. They perform an evaluation focused on performance using simulations during the design stage.

The presented frameworks highlight the importance of collecting accurate and detailed information as the basis for simulating the energy performance of buildings.

- The first framework addresses the project's characteristics and final systems, from the envelope to plug loads.
- The second framework emphasizes the importance of considering estimated use and operation as well as historical climate data to ensure the accuracy of the simulation.
- The third framework encompasses the simulation results, including the baseline and alternative design scenarios.

Together, these three frameworks allow for modeling and parameterizing the project in a way that creates realistic scenarios to enhance the building's energy performance. Climate, which is encompassed within the second data collection framework, is of utmost importance.

### C. Climate

NASA [27] defines that:

"Weather is the condition in which variables such as air temperature, relative humidity, rainfall, and wind are perceived in a specific region during a specific period. Climate, on the other hand, is the average behavior of these conditions in that region, taking into account several years or decades. While weather conditions can change rapidly and be unpredictable, climate is an established trend based on historical data."

Therefore, weather conditions are the constituent elements of climate. The definitions provided by Castelo Branco [28] for these variables are:

- Air temperature: an existing variable influenced by the rates of cooling and heating of the Earth's surface. These rates are directly linked to the amount of solar radiation the Earth receives, the composition of the Earth's

atmosphere through its connection to greenhouse gases (carbon dioxide and methane), the land cover with its vegetation, and human activities.

- Relative humidity: resulting from water evaporation on moist surfaces and transpiration occurring in vegetated areas.
- Air displacement: the movement of atmospheric air formed by differences in atmospheric pressure and air temperatures.
- Rainfall precipitation: resulting from a decrease in air temperature sufficient for air with a certain relative humidity to condense water, transforming it into liquid form as rain.

Understanding climatic variables is crucial for the design process and the development of photovoltaic generation systems. By considering the climatic conditions of a region, it is possible to identify the potential for solar energy generation and appropriately size the system. Moreover, knowledge of climatic variables allows for predicting seasonal variations in energy production, as well as the influence of factors such as cloud cover and rainfall. Thus, understanding climatic variables is essential for maximizing the efficiency and profitability of photovoltaic generation systems.

### C. Photovoltaic Generation System

The photovoltaic (PV) generation system consists of a converter system that converts solar radiation into electrical energy. It is constructed using solar cells that are interconnected to form a solar module. These systems can be grid-connected (on-grid) or operate independently with energy storage devices (off-grid) [29]. Photovoltaic systems are considered incentivized energy sources [18] because they are classified as a clean and renewable form of electricity generation, as they do not emit pollutants or greenhouse gases during electricity generation.

### D. BIPV Glasses

Materials for Building Integrated Photovoltaics (BIPV) consist of structures that incorporate photovoltaic cells (PV) into building elements. Examples of these structures include windows and roofs. These solutions are being envisioned as aesthetically attractive and efficient, bringing sustainability to energy production.

Glass that incorporates BIPV technology integrated into architecture presents opportunities for innovation in energy generation. There are examples of these technologies being used in buildings in São Paulo, the capital city of Brazil, which have shown energy consumption reductions of up to 15% annually [30].

## III. MATERIALS AND METHODS

Within the framework presented in this chapter, a description of the activities and actions undertaken to achieve the research objectives was provided. This includes the presentation of ideas, the tools involved, the

study area, and the materials used throughout the research.

In this context, various strategies can be adopted to increase the energy efficiency of a building, thereby reducing its consumption and associated electricity costs. Energy efficiency in buildings represents an interdisciplinary field of study, involving knowledge from engineering, architecture, physics, and other related areas.

The research follows several stages of development. The first stage involves the parameterization of the study through the characterization and construction definitions of the building used in the research. The second stage involves the characterization of occupants' consumption habits in the space. The third stage pertains to the collection of microclimate data for the building. In the fourth stage, computational analyses are conducted using simulations within Design Builder, focusing on environmental conditioning and lighting, and Solar Edge Generation Simulator, which includes modeling tests related to energy generation through photovoltaic sources. In the fifth stage, the climatic data used in the simulation is validated against on-site measurements and globally validated data from INMET. In the final stage, the results concerning consumption habits and cost-effectiveness are presented.

#### A. Collection of efficiency data

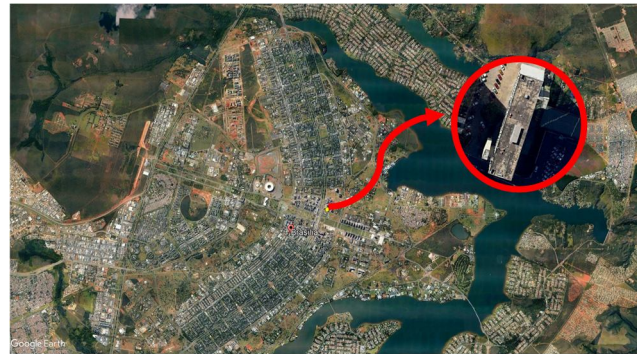
The *Palácio do Desenvolvimento* Building is a structure located in Brasília, Federal District, which houses the headquarters of the National Institute for Colonization and Agrarian Reform (INCRA). This building is a modern and imposing structure designed by architect Oscar Niemeyer, with twenty-three floors. The building features a range of facilities and services to accommodate employees and visitors, such as auditoriums, meeting rooms, a library, and parking. The *Palácio do Desenvolvimento* aims to provide a suitable environment for the implementation of INCRA's activities, which are focused on implementing public policies related to agrarian reform, land regularization, and sustainable development in rural areas of Brazil.

In this first stage, the main information and characteristics of the building located at SBN QD 01 Bloco D - *Edifício Palácio do Desenvolvimento, Asa Norte, Brasília*, Federal District were identified (Figure 2).



**Fig. 2.** *Palácio do Desenvolvimento* Building (INCRA Headquarters)

Following that, Figure 3 displays the location of the building in question in the city of Brasília. This image presents an overview of the surroundings of the structure and its geographical position in relation to the city.



**Fig. 3.** Map of Brasília and location of the *Palácio do Desenvolvimento* building (INCRA headquarters)

Its twenty-three floors are presented in Figure 4. The construction characteristics were used according to previous studies and are described in the following topics.

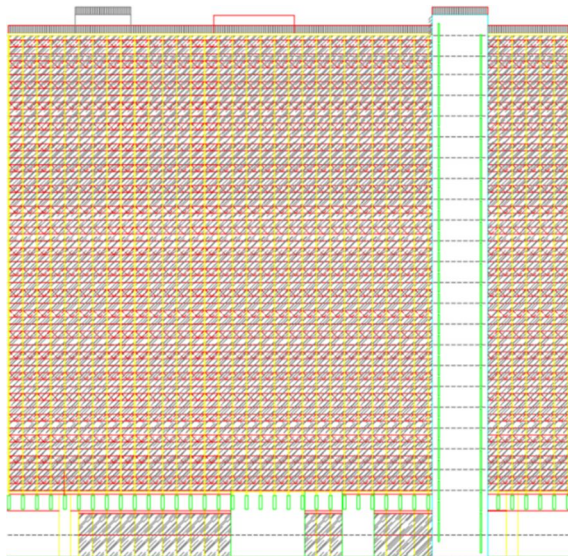


Fig. 4. West facade of Palácio do Desenvolvimento building

The evaluation of the building construction characteristics was conducted. In this survey phase, the literature provided by Santana [31] was used to establish the most common characteristics for office buildings in Brazil. Based on this study, it was found that buildings similar to Palácio do Desenvolvimento have external walls made of ceramic bricks with plaster on both sides and a roof composed of a concrete slab. This information was supplemented by the studies of Gabriel [23], who reorganized and presented the construction characteristics. Therefore, the gathered characteristics serve as a basis for future simulations, as shown in Figure 5 below. The collection of this information is important for understanding the composition of the building and conducting energy and thermal performance studies.

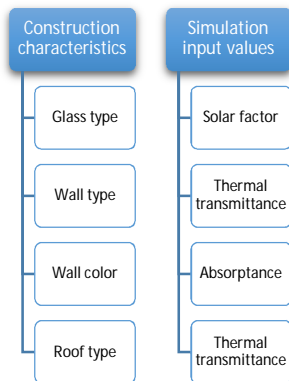


Fig. 5. Construction characteristics and simulation inputs

From the references, descriptive values for the building characteristics were obtained, as presented in Table 2. It should be noted that the glass color was verified through on-site visualization, while the walls were considered white. The accuracy and reliability of this information are essential for conducting subsequent analyses and studies

related to the building's performance and interventions.

TABLE II  
DESCRIPTIVE CHARACTERISTICS OF TYPICAL OFFICE BUILDINGS

<b>Thermal Transmittance (W/m<sup>2</sup>K)</b>	walls	2,47
	roofs	2,42
<b>Thermal Capacity [kJ/(m<sup>2</sup>.K)]</b>	walls	200
	roofs	187
<b>Absorptance</b>	walls	0,65
	roofs	0,70
<b>Glass</b>	color	smoke
	thickness	6 mm
	solar factor	0,83

The building's position was verified using the geolocation provided by the Google Earth application. Based on its geographic coordinates (15.79° S; 47.88° W), the orientations of its facades with window openings were measured. With the support of the "Ruler" tool in the application, the inclination of the facade was obtained with North as the reference. The images of the orientation measurement are presented in Figure 6.

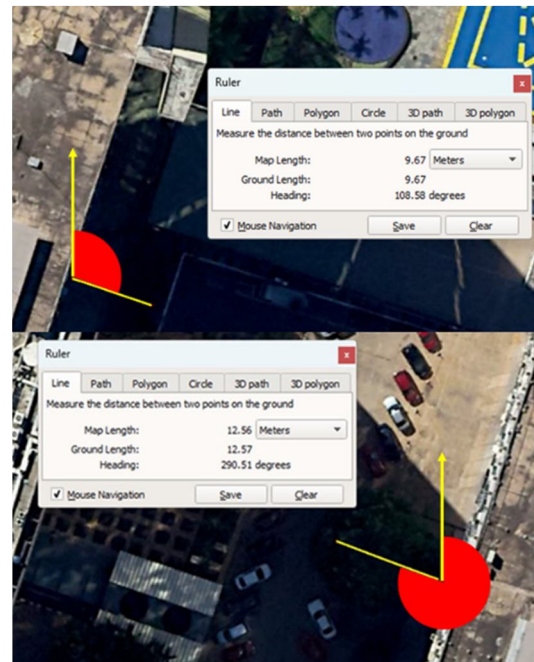


Fig. 6. Façade orientation

The following Table 3 summarizes the orientation of the openings on the West and East facades, with North as the reference.



TABLE III  
Orientation of Building Facades with OPENINGS

West Facade	East Facade
290°	108°

During the verification of the solar protection elements in the openings of the building facades, the internal movable louvers were inspected on-site. However, it was not possible to assess the efficiency of these elements.

During the replacement of the window glass and the application of a tinted film, the movable louvers had to be removed, as shown in Figure 7. During this process, it was found that the incorrect specification of the 4 mm glass resulted in cracks due to high heat, as reported by some firefighters. As a result, it was suggested to reconfigure and purchase materials with a thickness of 6 mm to solve the identified problem. The 6 mm thickness was used in the simulations.

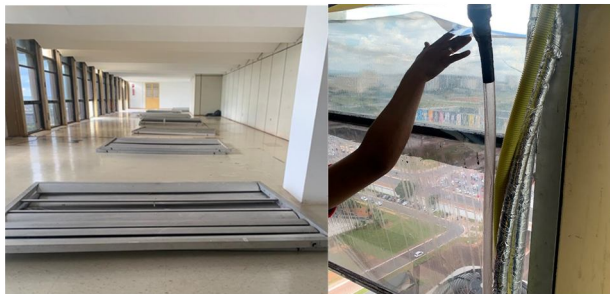


Fig. 7. Removal of louvers for window replacement

To estimate the number of occupants in the *Palácio do Desenvolvimento* building, interviews were conducted with the engineering and maintenance team of the building. Based on these interviews, it was found that some floors had been unoccupied since 2021, such as floors 20, 21, 22, and 23, while floors 4, 5, 6, 7, and 10 were not under the responsibility of INCRA and were therefore not considered in the analysis. Additionally, floors 12 and 14 were vacated and currently only accommodate a reduced workforce, such as the Banco do Brasil agency on the 14th floor. Prior to the pandemic, the building was occupied by approximately 1,440 people, with 80 people per floor. Currently, it is estimated that around 900 people occupy the building, with approximately 50 people per floor. The image in Figure 8 below shows the unoccupied floors of the building.



Fig. 8. Unoccupied floors

Characterizing the consumption profile and occupancy patterns is crucial for evaluating the energy efficiency of buildings. After collecting data from the building, it is possible to identify the main energy consumption patterns and estimate the number of occupants present in each area.

#### B. Characterizing the consumption profile and occupancy patterns

To characterize the energy consumption profile of the studied building, an interview was conducted with the engineering team responsible for building maintenance. During the interview, some of the main energy consumption patterns observed among occupants were identified. The performance characteristics suggested by Santana [31] were used to support the calculation proposed by the Energy Efficiency Program [18], as previously presented in Equation 1 and Equation 2. Figure 9 illustrates these performance characteristics. However, the analysis of energy consumption was limited to floors 11 to 23, as well as the ground floors A and B, due to the limited availability of energy bills.

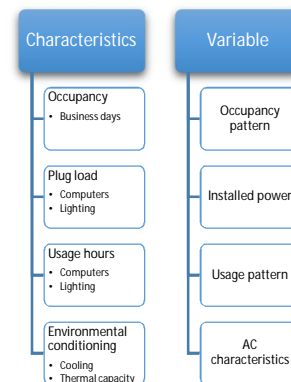


Fig. 9. List of the characteristics of the consumption profile and occupancy pattern

The technical specifications of the lighting equipment were obtained through an interview conducted with the engineering and maintenance team of the building. The

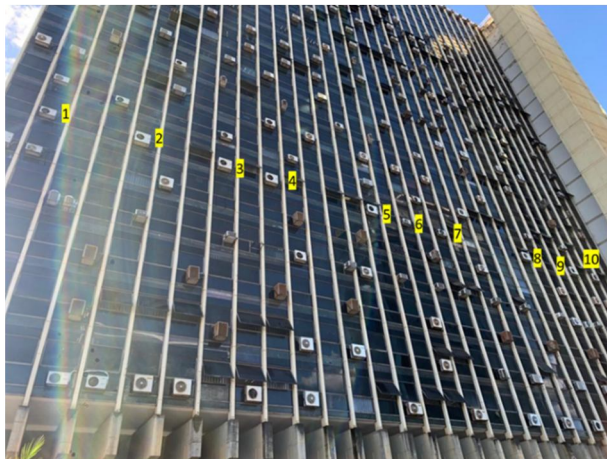


average power consumption of computers was obtained from catalogs provided by energy distributors [32]. The power rating of the air conditioners was validated through a sample verification of the condensers of some units installed on the roof of the building, as shown in Figure 10.



**Fig. 10.** Technical specifications of the air conditioning units in the building

The next step of the study involved visually verifying the quantity of air conditioning units suggested by the interview. For this purpose, the count of the number of condensers of the units installed on the facades of the building was carried out. This allowed confirming the average quantity of equipment per facade in the building. The visual verification of the equipment count is illustrated in Figure 11, where the count can be seen being conducted on one of the building's facades.



**Fig. 11.** Quantity of Air Conditioning Units per Floor and per Facade

After verifying the quantity of equipment, the consumption habits and operating times were standardized. The standard adopted was 5 working days per week, approximately 52 weeks per year. The estimated operating hours were from 8:00 AM to 6:00 PM for lighting and from 12:00 PM to 4:00 PM for air conditioning. These values were suggested based on a previous interview conducted with the building users.

Using the information on technical specifications and consumption habits, percentages were calculated for each end use of the systems involved in the analysis, and an

energy balance was constructed. In Table 4 below, a summary is provided of the average equipment per floor used in the study, indicating the corresponding systems (lighting, air conditioning, and computers) and their operating time. The 18th floor, which showed the highest energy consumption, was chosen for modeling and equation prescription.

**TABLE IV**  
Quantity Approximation of Equipment per Floor

System	Typey	Qty	Power	Operating Time	COP
Lighting	Tubular LEDs (T8)	220	9W	2080 h/yr	3,01
Air Conditioning	Floor-Ceiling	20	36.000 BTU/h	2080 h/yr	
Plug Load	Computers	50	250W [32]	2080 h/yr	

### C. Climate Data Collection

The microclimate data was measured with the assistance of the Vantage Vue Davis Wireless Weather Station installed on the building's rooftop. Through it, data on air temperature, relative humidity, wind direction and speed, as well as rainfall, are measured and validated using curves generated by the National Institute of Meteorology (INMET). Two reference months (October 2022 and January 2023) were selected for comparison and validation of the data from the weather station installed in the building with the data from INMET. Curves were plotted for these periods and a detailed descriptive statistic of the data was performed using Excel software.

In assessing the agreement between two sensors installed at different measurement points, the Bland-Altman statistical method was adopted. This method is widely used to compare the agreement between two quantitative measurements and identify possible systematic bias or excessive variation between them. In this study, the Bland-Altman test was applied to analyze the differences between the readings of the two sensors. The MATLAB software, a widely used platform for statistical analysis and data visualization, was chosen to perform the calculations and plot the Bland-Altman graph. MATLAB allowed for plotting the graph that illustrates the dispersion of points in relation to the mean and the limits of agreement. This statistical approach and the use of MATLAB provided a robust and objective assessment of the agreement between the sensors in this study. The script used for the calculations and plotting in MATLAB is presented in the attachments.

Once the information was validated, a climatic study of the year 2022 was conducted using the information provided by INMET. Curves were constructed, and a detailed descriptive statistic of the collected data was performed.

Regarding the information related to air velocity and direction, the WRPLOT View Freeware 8.0.2 software from Lakes Environmental was used. It allowed for the

percentage evaluation of the most frequent speeds and directions.

#### D. Simulation

The process of using simulations throughout energy efficiency projects is important because it allows designers, architects, and engineers to virtually evaluate and analyze the building systems, test components to be implemented, and facilitate the design of the processes involved before the construction planning phase.

By using simulations, difficulties and problems can be identified and corrected, while providing better suggestions for efficiency, safety, and performance. Within these proposals, there is the possibility to explore and evaluate different scenarios and hypotheses.

Considering this, it is necessary to follow several steps in defining a simulation. It tends to be part of the energy efficiency project and, in this case, follows a specific methodology. As recommended by Borgstein, Lamberts, and Hensen [33], during the design phase, the simulation should incorporate several models. First, the evaluation of the building's characteristics must be considered. Here are the evaluated characteristics:

- Envelope;
- Lighting;
- Environmental conditioning;
- Plug loads (with a focus on computers).

After gathering these parameters, which serve as the foundation for the project modeling, the building's usage and operation time are estimated. The information used was collected during interviews conducted with the technical staff of the engineering and maintenance department.

Next, a historical climatic evaluation of the location is performed and confirmed with the data used by the simulator. These values were validated with the microclimate data captured by the weather station installed on the building's rooftop.

With this information, some basic project guidelines were proposed, considering different scenarios inspired by literature references. For the envelope effects, studies were proposed regarding thermal treatment project formats with an impact on energy consumption [23], [31], [34]. Specific forms for office buildings were also considered [35], [36]. Thinking of innovative generation forms, the opportunity to suggest the incorporation of new materials for photovoltaic applications was explored. These scenarios include:

- Use of photovoltaic materials such as window glass;
- Implementation of a photovoltaic power plant on the building's rooftop;
- Combination of all solutions.

In Design Builder, the simulation of the current energy consumption was performed for the floor with the highest

energy consumption mapped through energy bills (18th floor). The consumption was parameterized according to the following details.

The simulation conducted in Design Builder followed parameter suggestions presented in the literature for office buildings' characteristics. The parameter values are the same as those previously presented in Table 2. For the walls, the thermal transmittance is 2.47 W/m<sup>2</sup>K, while for the roofs, it is 2.42 W/m<sup>2</sup>K. The thermal capacity of the walls is 200 kJ/(m<sup>2</sup>·K), and for the roofs, it is 187 kJ/(m<sup>2</sup>·K). The wall absorptance is 0.65, and the roof absorptance is 0.70. Regarding the glass used in the building, the color is smoke, the thickness is 6 mm, and the solar factor is 0.83.

Furthermore, Design Builder was used to simulate actions aimed at implementing Building-Integrated Photovoltaics (BIPV) in the windows of the floor. The parameters used were the native parameters of the Design Builder simulator. For the photovoltaic generation efficiency constant, a value of 0.15 was used. The fraction of the surface area with active solar cells was set to 0.90, and the nominal electrical output power was set to 48,000 W.

The number of occupants followed the standard used in the interview with the maintenance and engineering team, quantifying 50 people per floor in a space of 1,100 m<sup>2</sup> of floor area. Therefore, the occupancy density index used was 0.0458 people/m<sup>2</sup>. The coefficient of performance (COP) for the air conditioning system used was 3.01.

For the energy generation system installed on the rooftop, the photovoltaic system simulator from Solar Edge was used. Equipment with the highest technological competence and efficiency currently available was suggested. The equipment used in the simulation is presented in Table 5 below.

TABLE V  
EQUIPMENT SPECIFICATION USED IN THE SIMULATION

Equipment			
Modules		Inverter	
Qty	Power	Qty	Power
112	550 kWp	1	75 kW

From this, it was possible to assess costs, economic feasibility, and return on investment. Through this evaluation, the period required for the cash flow generated by the installed photovoltaic system to equal the initial investment value was determined. In other words, the payback period of the capital invested in the project was calculated.

For the calculation, the market prices for installing the photovoltaic system were verified through budgeting and price comparison. Four different companies provided quotations. The average of the prices from the four quotations (Table 6) was used as the cost to be invested in the project.

TABLE VI  
VALUES VERIFIED IN THE PRICE ASSESSMENT

	Budget 1	Budget 2	Budget 3	Budget 4
<b>Equip.</b>	R\$ 269.276,9 2	R\$ 204.194,3 1	R\$ 200.656,4 5	R\$ 194.600,00
<b>Service</b>	R\$ 115.404,3 9	R\$ 87.511,85	R\$ 85.995,62	R\$ 83.400,00
<b>Total</b>	R\$ 384.681,3 1	R\$ 291.706,1 5	R\$ 286.652,0 7	R\$ 278.000,00
<b>Ave</b>	R\$ 310.259,88			

Furthermore, the cost of the kWh charged by the Neoenergia distributor was verified. The rate charged was verified in the last electricity bill provided in the field survey for the month of December. Additionally, using the information provided by ANEEL [37], the average readjustment rate for Neoenergia in Brasília was determined. These values are presented in the following Table 7.

TABLE VII  
ENERGY TARIFF VALUES AND ANNUAL ADJUSTMENT RATES

Value of Tariff	
As of December/2022	Annual Adjustment
[R\$/kWh]	-
R\$ 0,952049	21,54%

Having the information regarding the energy charges from the energy distributor, the indices of market values for system operation and maintenance were verified. The percentage costs for the investment year, annual adjustments, and annual efficiency loss of the system were measured. The operation and maintenance costs, along with their adjustments, were obtained from the budgeting process, while the efficiency loss was obtained from the photovoltaic module catalog [38]. The indices are presented in the following Table 8.

TABLE VIII  
ENERGY TARIFF VALUES AND ANNUAL ADJUSTMENT RATES

Operation and Maintenance		
% From final budget	Annual Adjustment	Loss of efficiency
0,50%	4,50%	0,55%

In the following Table 9, you can see a summary of the installation costs and the characteristics of the proposed system.

TABLE IX  
COST AND SYSTEM SUMMARY

Proposed System			
Module Power	Module Quantity	Nominal Power	% of Total Consumption
[Wp]	[un]	[kWp]	-
550	112	61,6	7,78%
PV System Cost	Other Costs	Cost per kWp	Total Cost
[R\$]	[R\$]	[R\$/kWp]	[R\$/kWp]
R\$ 310.259,88	R\$	R\$ 5.036,69	R\$ 310.259,88

With the support of Excel software, the financial

inflows and outflows related to the investment in the system, the cost of energy charged by the distributor, and the expected annual energy savings from the system were organized. After that, considering all the influences of rates and taxes, the calculated values were annualized to determine the payback period of the investment.

#### IV. RESULTS AND DISCUSSION

In this section, the results obtained through the methodologies described in the previous chapter were presented and analyzed. Patterns and associations among the studied variables were identified, aiming to address the research questions. The analysis of the results allowed for a deeper understanding of the study subject, providing insights for the conclusion and recommendations of the work.

##### A. Constructive and usage characteristics

By following the established methodology, it was possible to organize the collected information and use it as a basis in the simulation steps. These parameters, which encompass the building's characteristics, solar radiation protection elements, and the number of occupants present in the space, play a fundamental role in the analysis of the thermal performance of a building and the evaluation of occupants' comfort. Each of these aspects contributes significantly to understanding the thermal behavior of the built environment and identifying possible improvements in the design.

The building's construction characteristics include elements such as the materials used in construction, thermal insulation, external surface area, building orientation, and the amount of glazing. These factors have a direct impact on heat transfer between the indoor and outdoor environments, thereby influencing the temperature within the building. In the simulations, these characteristics were considered to understand how they contribute to the overall thermal performance of the built environment.

Solar radiation protection elements, such as louvers (Figure 12), play a crucial role in controlling the entry of solar radiation into the building's interior. These elements aim to regulate the amount of direct and diffuse solar radiation that reaches the internal surfaces of the building. Thus, they play an important role in determining the temperature and thermal comfort of occupants. In the simulations, these elements are modeled to evaluate their efficiency in reducing solar heat gain and, consequently, contributing to thermal comfort.





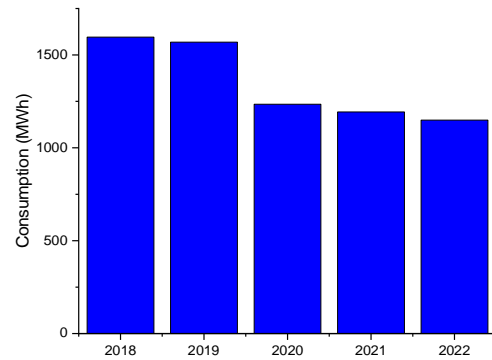
**Fig. 12.** Internal louvers

Another relevant parameter was the number of occupants present in the environment. The number of people in a space has a direct impact on the internal thermal load. Each individual generates metabolic heat, which is released into the environment through physiological processes. Therefore, the number of occupants influences the cooling or heating demand required to maintain a comfortable temperature in the space. In the simulations, the number of occupants is taken into account to determine the internal thermal load and assess its impact on the temperature and thermal comfort of the space.

By considering these parameters in the simulations, a comprehensive analysis was possible. This allowed for the identification of possible deficiencies or improvement opportunities and the optimization of the project in terms of energy efficiency. In this way, informed decisions could be made about the design, such as selecting appropriate materials, properly sizing energy sources, and understanding which typology of consumption has the greatest impact on the building.

### B. Building Energy Consumption and Energy Balance

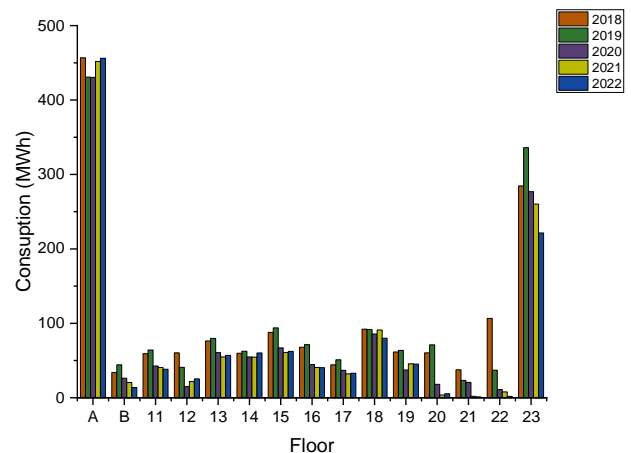
After examining the historical energy consumption from the 11th floor to the 23rd floor, as well as the ground floors A and B, a reduction in reference values was observed starting from the year 2020. In previous years, the current energy consumption for these floors was 1,596 MWh and 1,569 MWh for 2018 and 2019, respectively. In other words, there was a considerable reduction in consumption values in the following years, representing 1,235 MWh for 2020, 1,196 MWh for 2021, and 1,149 MWh for 2022. This behavior is easily observed in Figure 13 below.



**Fig. 13.** Building Energy Consumption between 2018 and 2022

The reduction in electricity consumption at *Palácio do Desenvolvimento* was observed as a result of decreased building usage, in line with the social distancing measures implemented to curb the spread of COVID-19 [39]. These measures included social distancing, travel restrictions, and the cancellation of in-person meetings and events. Comparative studies that evaluated energy consumption in commercially occupied buildings during business hours, with similar patterns and typologies to *Palácio do Desenvolvimento*, have confirmed the relationship between usage behavior and energy reduction [16], [17].

It is known that energy consumption can vary depending on the size of the building, floors, and the purpose of the space. Through the analysis of the annualized energy consumption per floor in Figure 14, distinct behaviors can be observed for each purpose and destination of the floors allocated in the building structure. The points of highest consumption are located at the extremes.



**Fig. 14.** Annualized consumption per floor

When analyzing the consumption pattern for each floor of the building over the course of a year, it was observed that the most representative values were found on the 23rd floor and Ground Floor A. These floors stood out due to the presence of pumping systems and motors used

in the elevators on the 23rd floor, as illustrated in Figure 15. However, regarding Ground Floor A, it is important to mention that there was a noise of information during the interview, as the authorities reported the need for additional authorizations to access the required information.



**Fig. 15.** Elevators with high energy-consuming electric motors

According to the literature references [40], [41], it is suggested that this high consumption can be attributed to data centers and the necessary cooling required for their operation. Furthermore, it is evident that the 18th floor encompasses the highest energy consumption when considering the normal usage patterns for the office-type building.

The data provides information on the electrical energy consumption across different floors from 2018 to 2022. Table 10 below illustrates the difference between the consumption levels of the other floors compared to those previously mentioned. It is worth noting that the floors with the highest consumption were dated in the years 2018 and 2019.

**TABLE X**  
ANNUALIZED CONSUMPTION BY FLOOR & FLOORS WITH HIGHEST CONSUMPTION

	Ground Floor A	Ground Floor B	11st Floor	12nd Floor	13rd Floor	14th Floor	15th Floor	16th Floor
Yr	MWh	MWh	MWh	MWh	MWh	MWh	MWh	MWh
18	456,68	33,88	59,24	60,36	76,4	59,84	87,88	67,84
19	430,88	44,28	64,2	40,87	79,72	62,52	93,92	71,36
20	430,36	26,36	42,64	14,96	60,6	54,92	67,04	44,68
21	451,84	20,56	40,76	21,76	54,84	54,56	60,76	40,76
22	456,16	13,8	38,36	25,28	56,96	60,28	62,4	40,44
$\bar{x}$	445,18	27,78	49,04	32,65	65,7	58,42	74,4	53,02
-	430,36	13,8	38,36	14,96	54,84	54,56	60,76	40,44
+	456,68	44,28	64,2	60,36	79,72	62,52	93,92	71,36
	16° Andar	17° Andar	18° Andar	19° Andar	20° Andar	21° Andar	22° Andar	23° Andar
	MWh	MWh	MWh	MWh	MWh	MWh	MWh	MWh
18	67,84	44,28	92,24	61,48	60,32	37,58	106,6	284,7
19	71,36	51,08	91,76	63,64	71,08	23,32	37,04	336

20	44,68	36,84	85,72	37,26	18,1	20,62	11,2	276,9
21	40,76	32,04	91	45,64	3,7	1,94	7,96	260,2
22	40,44	32,96	80	45,24	5,38	1,2	1,88	221,38
$\bar{x}$	53,02	39,44	88,14	50,65	31,72	16,93	32,94	275,84
-	40,44	32,04	80	37,26	3,7	1,2	1,88	221,38
+	71,36	51,08	92,24	63,64	71,08	37,58	106,6	336

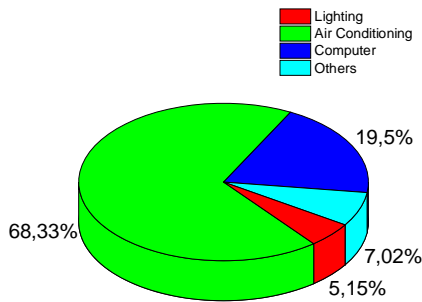
When analyzing the electricity consumption on each floor, a significant variation can be observed, indicating that the energy consumption may be related to the use of space and activities carried out on each floor. This can be explained by the presence of equipment such as elevators, air conditioning systems, and intense lighting, as well as other activities taking place on those floors, such as offices and meeting rooms.

In summary, the analysis of these results can provide valuable insights into how electricity consumption is distributed in the building and how it varies over time. With this information, it is possible to identify opportunities to reduce electricity consumption on specific floors or identify specific equipment or activities that consume a significant amount of energy and can be optimized to reduce electricity consumption throughout the building.

Upon analyzing the information regarding the energy consumption of the 18th floor, it can be observed that this floor has a significant consumption compared to the other floors in the building. The consumption ranges between 80 MWh and 92.24 MWh, which may indicate a high usage of electronic equipment and lighting since the 18th floor is dedicated to office activities. It is important to highlight that the average energy consumption of the 18th floor is 88.14 MWh, a value well above the overall average of the building when considering floors 11th to 19th, which have similar activities, at 56.83 MWh. This high consumption may indicate the need for reviewing energy usage practices on this floor, such as using more efficient equipment and raising awareness among employees regarding rational electricity use. By implementing these measures, it is possible to reduce energy consumption and consequently, the costs associated with electricity in the building.

Through conducting an energy balance of the 18th floor, it was possible to identify that its highest energy consumption is related to cooling loads within the environment, as illustrated in Figure 16. These loads may include air conditioning systems. It is important to note that cooling large spaces, such as those found in offices, requires a considerable amount of energy. To optimize energy consumption, it is recommended to evaluate the efficiency of the cooling systems used, consider more efficient cooling alternatives, and implement energy management practices, such as using presence sensors and scheduling equipment operating hours. By doing so, it is

possible to reduce energy consumption dedicated to cooling the environment on the 18th floor and promote a more efficient utilization of energy resources.



**Fig. 16.** Energy Balance of the 18th Floor

The fact that environmental conditioning is the load that consumes the most energy in office environments is a commonly observed behavior [42]. Furthermore, Santana [31] reports that other loads involved in the consumption of office buildings, such as lighting and equipment plugged into outlets, also present similar consumption percentages. These pieces of information reinforce the importance of adopting efficient energy management strategies, such as using more efficient environmental conditioning technologies and employing lighting equipment with higher energy efficiency. This way, it is possible to optimize energy consumption in these areas and seek a balance between occupant comfort and environmental sustainability.

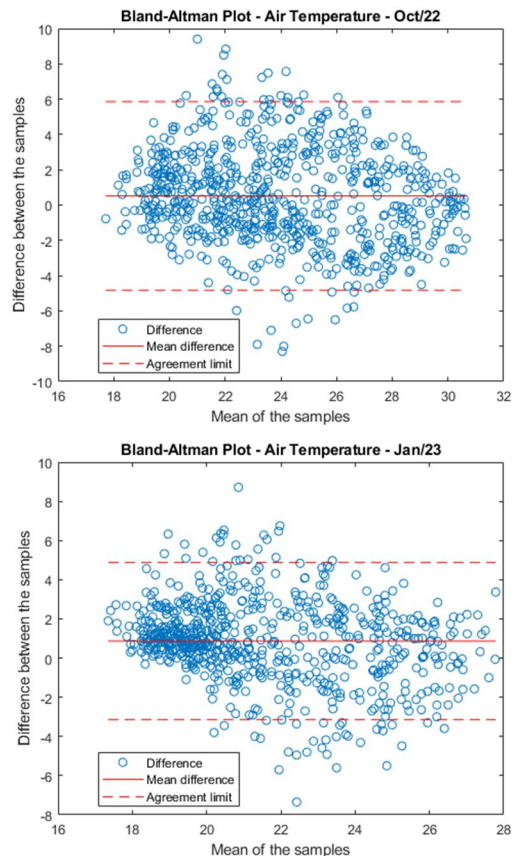
After evaluating the consumption, data regarding the collected climatic information in the building and data from the INMET database [43] are retrieved.

*C. Validation of meteorological station data*

Based on the presented data, relationships can be observed between the measurements of air temperature, relative humidity, and wind speed carried out at INCRA (on the top of the building) and at INMET (reference meteorological station).

In the case of air temperature, it was observed that the average temperature at INCRA (24.21°C in October 2022 and 21.92°C in January 2023) was slightly higher than at INMET (23.68°C in October 2022 and 21.03°C in January 2023), indicating that the higher location on the top of the building may be subject to greater sun exposure and direct solar radiation, contributing to higher temperatures. This difference is also reflected in the median, with higher values at INCRA (23.90°C in October 2022 and 23.15°C in January 2023) compared to INMET (21.30°C in October 2022 and 20.20°C in January 2023). When evaluating the Bland-Altman plots,

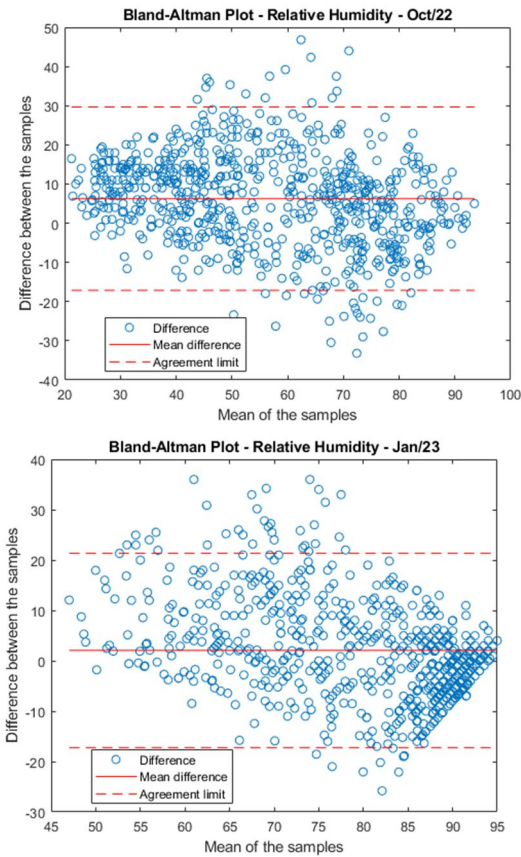
shown in Figure 17, it can be observed that several points are concentrated around the mean difference and most of the points fall within the limits of agreement lines, indicating good agreement between the sensors. The concentration of points near the mean indicates consistent agreement between the sensor readings, while most points within the limits of agreement indicate that the differences between the measurements are within an acceptable range. This positive analysis of agreement between the sensors strengthens the reliability and consistency of the air temperature measurements carried out by them.



**Fig. 17.** Bland-Altman test for air temperature (oct/22 and jan/23)

Regarding relative humidity, it was found that the average humidity at INCRA (58.87% in October 2022 and 80.55% in January 2023) is higher than at INMET (52.65% in October 2022 and 78.55% in January 2023). The median also shows this trend, with higher values at INCRA (58.87% in October 2022 and 80.55% in January 2023) compared to INMET (52.65% in October 2022 and 78.55% in January 2023). Analyzing the Bland-Altman plots shown in Figure 18, there is a significant concentration of points around the mean difference and most of the points fall within the limits of agreement lines. These results suggest agreement between the evaluated sensors.

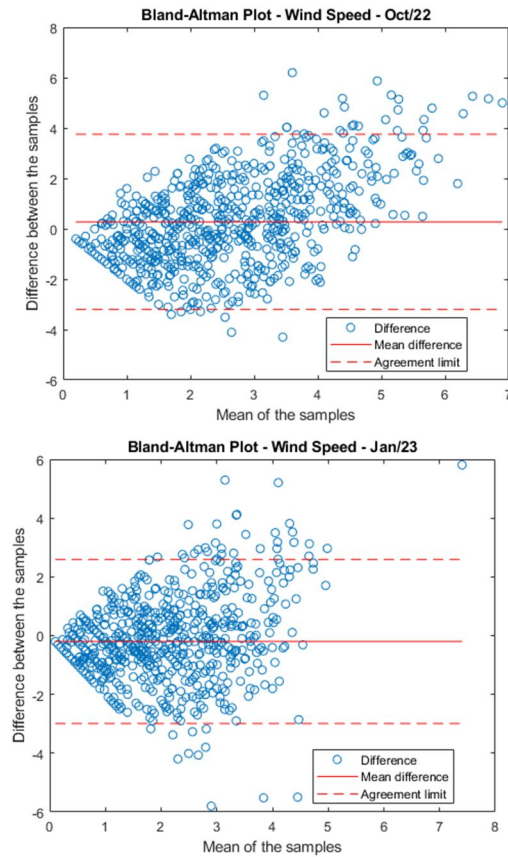




**Fig. 18.** Bland-Altman test for relative humidity (oct/22 and jan/23)

In regard to wind speed, differences were found between the measurements from INCRA and INMET. The data from INMET revealed lower speeds compared to the weather station at the top of the building. This disparity can be attributed to the difference in spatial location of the data collection stations and the variation in height at which the equipment is installed. The averages for the sensor installed at INCRA were 2.68 m/s in October 2022 and 1.82 m/s in January 2023. The INMET data showed 2.43 m/s in October 2022 and 2.05 m/s in January 2023.

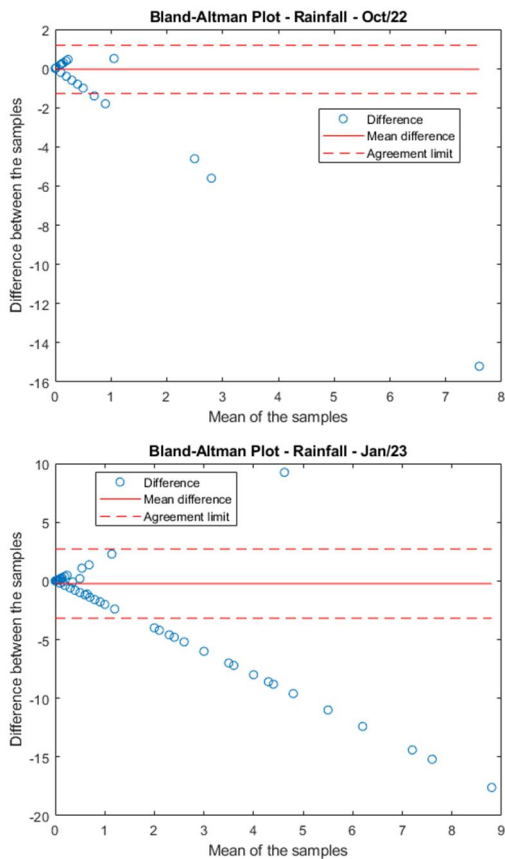
Analyzing the Bland-Altman plots presented in Figure 19 for the wind speed analysis, there is a dispersion of points around the mean difference, and most of the points fall within the limits of agreement lines. This indicates good agreement between the sensors used to measure wind speed. Most points within the limits of agreement indicate that the differences in measurements are within an acceptable range. These results reinforce the reliability of the wind speed measurements performed by the sensors in question and provide a solid foundation for their use in related studies or applications.



**Fig. 19.** Bland-Altman test for wind speed (oct/22 and jan/23)

Regarding rainfall precipitation, the collected data indicate differences between the meteorological stations of INCRA and INMET. During the analyzed period, it was observed that the INCRA station recorded a higher average precipitation compared to the INMET station. In October 2022, the average precipitation at INCRA was 0.01 millimeters, while at INMET it was 0.05 millimeters. In the month of January 2023, this trend persisted, with INCRA recording an average of 0.02 millimeters and INMET 0.26 millimeters. These discrepancies can be attributed to factors such as the geographical location of the stations and possible variations in rainfall distribution across these areas.

When analyzing the Bland-Altman plots, displayed in Figure 20, for the evaluation of rainfall precipitation, it is evident that there are scattered points beyond the limits of agreement lines and distant from the mean difference line. These results indicate a significant disagreement between the sensors used to measure rainfall precipitation. The dispersion of points outside the agreement lines suggests excessive variation in measurements or a systematic bias between the sensors. Furthermore, the presence of points distant from the mean difference line suggests considerable inconsistency between the sensor readings. This analysis converges on the influence of geographical location difference in sensor measurement.



**Fig. 20.** Bland-Altman test for rainfall (oct/22 and jan/23)

Overall, the results indicate that the location of data collection points and the context in which they were collected are important when interpreting climate data. Factors such as altitude, sun exposure, and wind can play a significant role in the variation of temperatures and humidity within the same city. However, there was consistency in the climate patterns throughout the year, which allows for the use of annual data from INMET for building analysis, particularly regarding air temperature and relative humidity.

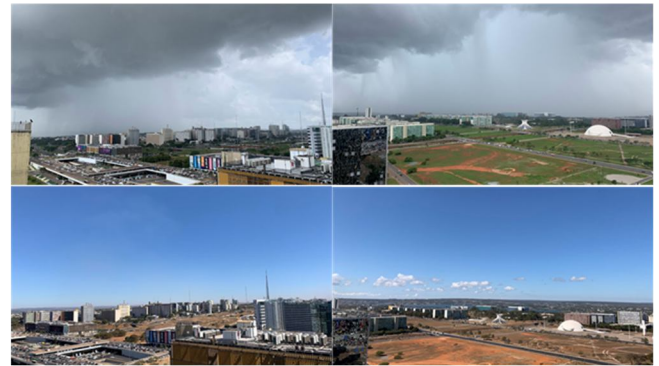
#### D. Climatic Variables

After validating the INMET data with the sensor mapped data installed in the building, an annual evaluation of climatic variables was conducted. In the year 2022, the annual average air temperature was 21.25°C, with a median of 20.8°C and mode of 19°C. These values indicate a variation throughout the year, with half of the observations below 20.8°C and a significant frequency of records around 19°C. The standard deviation of 3.95°C reveals considerable data dispersion in relation to the mean, reflecting the climatic variability of the region. The temperature range between 5.3°C and 32.7°C encompasses the minimum and maximum values recorded throughout the year.

In Brasília, in the year 2022, the average relative

humidity was 63.53%, with a median of 65% and mode of 93%. This indicates considerable variability throughout the year, with values oscillating between relatively low and high humidity levels. The standard deviation of 20.92 reflects data dispersion in relation to the mean, demonstrating the influence of seasonal climatic factors. The range of relative humidity variation was 83 units, with minimum values recorded at 13% and maximum values reaching 96%. These results highlight the importance of understanding relative humidity for evaluating human comfort, health, and impacts on different sectors such as agriculture and infrastructure.

The average rainfall precipitation was 0.15 mm, with both median and mode at 0 mm, indicating a predominance of rainless days. The standard deviation of 1.39 mm reveals the variability of the data, reflecting the presence of more intense rainfall events in certain periods. The variation between the minimum and maximum rainfall values was 46.2 mm, encompassing a wide range of occurrences. These results confirm the characteristic climate of Brasília, known for its rainy summer and dry winter, where precipitation is low, and the frequency of rainless days is predominant. The characteristics of the rainy summer and dry winter, mentioned earlier [28], [44], [45], are confirmed by the analysis of rainfall precipitation throughout the year 2022. Figure 21 provides a visual overview of the behavior of these two climatic characteristics to which Brasília is subjected.



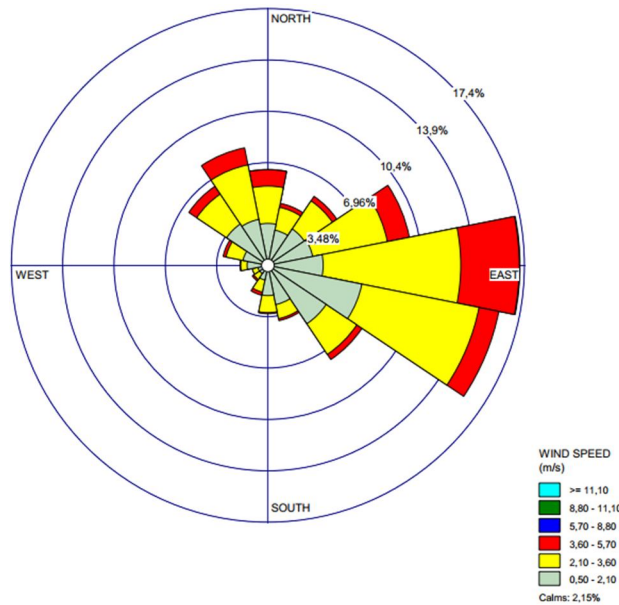
**Fig. 21.** Comparison of climatic characteristics throughout the year 2022

This seasonal precipitation is also important for the periodic cleaning of dust particles that may reduce the efficiency of the suggested photovoltaic modules as part of energy efficiency measures [46].

The average wind speed in the year 2022 was 2.25 m/s, with a median of 2.2 m/s and a mode of 1.8 m/s. The standard deviation of 1.04 m/s indicates a moderate dispersion of the data around the mean, reflecting significant variations throughout the analyzed period. The wind speed variation recorded minimum values of 0.1 m/s and maximum values of 8.1 m/s, with a range of 8 m/s. These results reveal a variable wind behavior, with a relatively symmetric distribution of the data. The presence of winds suitable for promoting thermal comfort is

confirmed, especially considering the speed spectrum between 1.5 m/s and 3 m/s, which corresponds to a safe and comfortable range of air movement [47].

In Brasília, a significant incidence of wind movements directed towards the east and its subdivisions was observed throughout the year 2022. Figure 22 presents the mapped incidence of these wind movements. It is noteworthy that the highest occurrence of winds was in the speed range between 2.10 and 5.70 m/s. These data support the suggestion of using elements such as louvers for natural ventilation, with appropriate positioning and angles to maximize the utilization of the predominant wind flow.

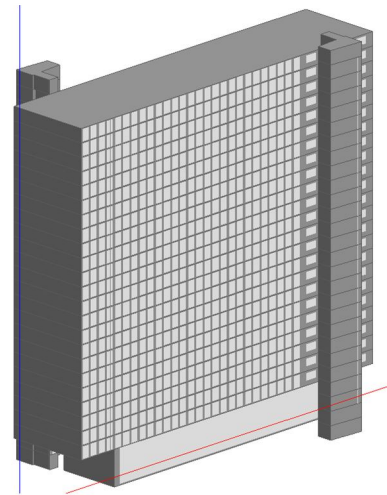


**Fig. 22.** Direction of incidence in the winds from jan/22 to dec/22

*D. Simulations*

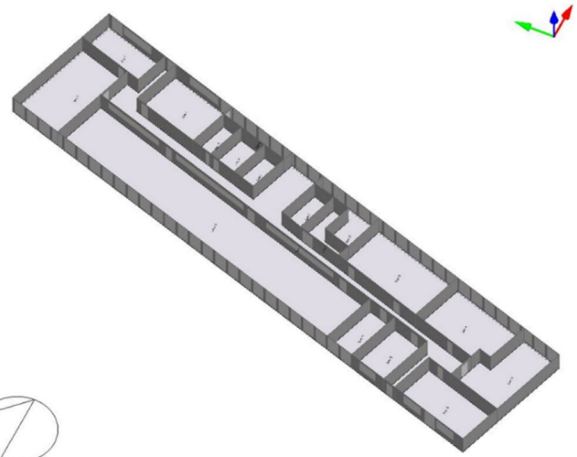
In this stage, the results obtained from the simulations conducted for energy consumption demand, photovoltaic generation, and the application of Building Integrated Photovoltaics (BIPV) technology on the building's windows are presented.

The initial phase of the simulation involved modeling the building using Design Builder software for energy analysis. However, due to licensing limitations of the software, which allowed simulations for only 50 zones, certain adaptations were necessary to overcome this constraint (Figure 23).



**Fig. 23.** Building modeling

One of the difficulties encountered was the lack of data from certain floors of the building during the survey. To address this situation, the decision was made to select the floor with the highest energy consumption profile, which was used as a representative for the simulation (Figure 24).

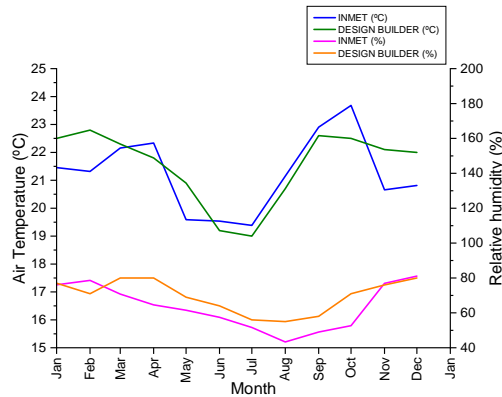


**Fig. 24.** Example of quantitative zones with limitation on simulation

This was considered a viable solution to obtain relevant results. It is important to emphasize that, despite these limitations, the building modeling was carried out with the highest possible precision, considering the gathered information, theoretical references [23], [31], and aiming to represent the construction characteristics and consumption systems present in the studied building. The appropriate use of climatic variables, consumption habits, and construction characteristics of a building was of utmost importance to ensure the expected energy consumption results. These three elements are intrinsically related and have a significant impact on energy consumption performance and occupant well-being.



After the modeling based on the identified parameters, the climatic data used by the simulator was verified. By considering local weather conditions such as air temperature, relative humidity, and wind speed, the validity of the database used in Design Builder was confirmed. The curves of the mentioned data are shown below (Figure 25).



**Fig. 25.** Comparison of climatic data between INMET and Design Builder

The collected air temperature data from INMET and simulated data through the Design Builder software were presented. The average air temperature recorded by INMET was 21.25°C, while in the Design Builder, it was 21.53°C. The median in INMET was 21.23°C, while in the Design Builder, it was 22.05°C. The standard deviation was 1.36°C in INMET and 1.31°C in the Design Builder, indicating a certain dispersion of the data in both cases. The sample variance was 1.85°C in INMET and 1.71°C in the Design Builder. The range between the minimum and maximum values was 4.3°C in INMET and 3.8°C in the Design Builder. These results show that, overall, the measured and simulated air temperatures are closely aligned, although there may be slight differences between the two datasets.

As for the relative humidity results, the average relative humidity recorded by INMET was 63.64%, while in the Design Builder, it was 69.75%. The median values were 63.06% in INMET and 71% in the Design Builder. The standard deviation was 12.95% in INMET and 9.48% in the Design Builder, indicating greater variability in the collected data compared to the simulated data. The sample variance, which is a measure of data dispersion from the mean squared, was 167.76% in INMET and 89.84% in the Design Builder. The range, representing the difference between the maximum and minimum values of the data, was 37.73% in INMET and 25% in the Design Builder, indicating greater variation in the collected relative humidity values compared to the simulated data.

Regarding wind speed, the average recorded by INMET was 2.25 m/s, while in the Design Builder, it was 2.15 m/s. The median values were 2.19 m/s in INMET and 2.05 m/s in the Design Builder. The standard

deviation was 0.2 m/s in INMET and 0.48 m/s in the Design Builder, indicating greater variability in the simulated data compared to the collected data. The sample variance was 0.04 m<sup>2</sup>/s<sup>2</sup> in INMET and 0.23 m<sup>2</sup>/s<sup>2</sup> in the Design Builder. The range was 0.53 m/s in INMET and 1.5 m/s in the Design Builder, indicating greater variation in the simulated wind speed values compared to the collected data.

Upon analyzing the simulated and collected results, it was observed that there is some similarity between the air temperature, relative humidity, and wind speed data. The average air temperature in INMET was 21.25°C, while in the Design Builder, it was 21.53°C. Both values show proximity, indicating a tendency for similar behavior. The same can be observed for relative humidity, with an average of 63.64% in INMET and 69.75% in the Design Builder. Although there is a discrepancy in absolute values, the relative variation between the data is comparable. As for wind speed, the averages also showed relative similarity, with 2.25 m/s in INMET and 2.15 m/s in the Design Builder. This agreement in the results suggests that the simulations carried out with the simulator's database were able to reproduce, to some extent, the observed climatic characteristics in the data collection.

After validating the simulator's accuracy regarding climate and specific parameters, the simulated energy consumption for the 18th reference floor was obtained. This approach allowed for a more precise estimation of energy consumption for the specific floor, considering the construction characteristics, consumption habits, and other relevant factors for the building's energy performance. Thus, the simulated consumption obtained for the 18th floor was 86.03 MWh. The simulated values converged towards the average found with the prescribed equation and calculated by PROPEE, verified at 88.14 MWh, as shown in Table 10.

Based on the simulated energy consumption for the specific floor, the need to meet this energy demand in a sustainable and efficient manner was identified. To achieve this, the installation of a photovoltaic generation system on the building's rooftop was considered, capable of completely supplying the energy consumption of the 18th floor. In addition, photovoltaic generation provides long-term economic benefits, as the energy generated by the system can be used self-sufficiently, resulting in reduced electricity costs. Thus, the connection between the simulated energy consumption on the floor and the installed photovoltaic generation system on the rooftop demonstrates the pursuit of a sustainable and economically viable solution to meet the building's energy needs.

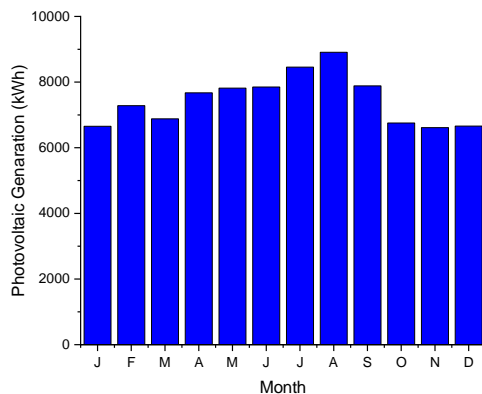
Considering this, a simulation of photovoltaic generation was performed. However, it was necessary to restrict some of the identified shading points due to the presence of elevated areas that created shadows, identified

by the purple points in Figure 26. This limitation can affect the efficiency of the photovoltaic system, as the presence of shading on one module can affect the energy production of the entire array. Therefore, it is important to consider these points in the installation of the photovoltaic system to ensure its efficiency and economic viability.



**Fig. 26.** Shading areas at the photovoltaic system

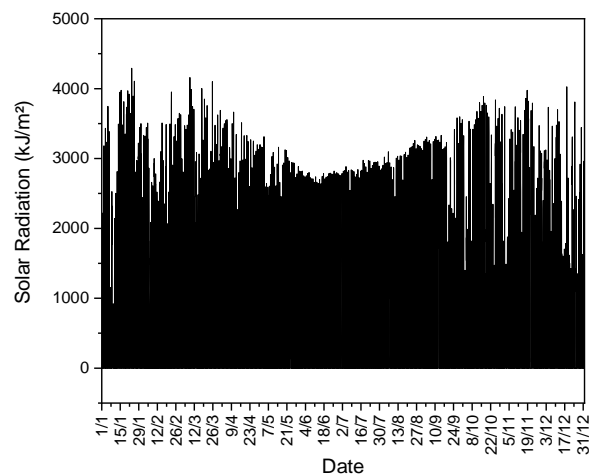
Through the simulation of photovoltaic generation, it was possible to evaluate the potential of solar energy production for the building in question. Various parameters were considered in the simulation, such as geographic location, tilt and orientation of the solar panels, and the availability of solar radiation. Figure 27 presents the month-by-month simulated generation potential, considering the planned equipment as a solution for the building. This detailed analysis allows for visualizing the variation in generation potential throughout the year, enabling a better understanding of the performance of the photovoltaic system and assisting in decision-making regarding equipment installation and sizing.



**Fig. 27.** Simulated photovoltaic generation for the building.

It is possible to observe that the months of July, August, and September show the highest peaks of solar generation potential. The justification for the high energy generation during these months can be attributed to favorable conditions, such as clear skies and suitable air temperature. During this period, it is common to have lower cloud coverage and a greater number of sunny days, which allows for a higher capture of solar radiation by the photovoltaic panels. Additionally, the air temperature is usually at a level that provides better efficiency for the generation system, avoiding performance losses due to high temperatures. These favorable conditions contribute to optimizing the performance of the photovoltaic system, resulting in higher electricity generation.

The analysis of meteorological data reveals some aspects that can explain the higher energy generation in the mentioned months. However, Figure 28 reveals a contradictory behavior regarding the detailed solar radiation provided by INMET. Contrary to what would be expected, the months with the highest energy generation do not necessarily show the highest level of solar radiation. This apparent discrepancy between the patterns of photovoltaic energy generation and the mapped solar radiation highlights the importance of considering other factors, such as the efficiency of the photovoltaic system and the influence of additional climatic variables, including high temperatures that can create conditions of low efficiency, for a more comprehensive and accurate analysis.



**Fig. 28.** Solar radiation measured for Brasilia.

Several studies have highlighted the influence of high solar radiation on the temperature of photovoltaic modules, which can result in overheating and loss of equipment efficiency, negatively impacting energy generation. This relationship is consistent with the findings of recent research [48], [49], reinforcing the importance of considering air temperature as a determining factor in the performance of the photovoltaic generation system.

Based on the listed operating conditions of the

simulated system, it was possible to obtain an annual energy generation forecast. It corresponds to 89.44 MWh, higher than the energy demand of the 18th floor, estimated at 88.14 MWh on average annually calculated by PROPEE and 86.03 MWh simulated in Design Builder. This difference indicates that the photovoltaic generation system would be able to fully meet the energy needs of this specific floor.

From the information obtained through the energy generation simulation, calculations of costs, economic feasibility, and financial return of the photovoltaic system (payback) were performed. When considering such a high tariff adjustment factor as recorded in 2022, at 21.54%, a significant increase in the cost of energy supplied by the utility was observed, as evidenced in Table 11. This projection further reinforces the importance of measures aimed at installing the photovoltaic system, as it offers an additional incentive. Through these analyses, it was possible to evaluate more accurately the investment payback periods, considering the impact of energy tariffs. This contributed to substantiating the decision-making process regarding the implementation of the photovoltaic system and demonstrates the financial benefits that can be achieved over time.

TABLE XI  
COST EVALUATION AND RETURN ON INVESTMENT

Year	Generated Energy	Current Consumed Energy	Tariff	Energy Cost Without PV
-	[kWh]	[kWh]	[R\$/kWh]	[R\$/ano]
0	0	0	0	R\$-
1	R\$ 89.438,00	R\$ 1.149.000,00	R\$ 0,95	R\$ 1.093.904,76
2	R\$ 88.946,00	R\$ 1.149.000,00	R\$ 1,16	R\$ 1.329.531,85
3	R\$ 88.457,00	R\$ 1.149.000,00	R\$ 1,41	R\$ 1.615.913,01
4	R\$ 87.970,00	R\$ 1.149.000,00	R\$ 1,71	R\$ 1.963.980,67
5	R\$ 87.487,00	R\$ 1.149.000,00	R\$ 2,08	R\$ 2.387.022,10
6	R\$ 87.005,00	R\$ 1.149.000,00	R\$ 2,52	R\$ 2.901.186,66
Year	Energy Cost With PV	Money Savings	Total Cost	O&M
-	[R\$/ano]	[R\$/ano]	[R\$]	[R\$]
0	R\$-	R\$-	-R\$310.2600,00	R\$-
1	R\$ 1.008.755,37	R\$ 85.149,39	R\$-	-R\$ 1.551,30
2	R\$ 1.226.610,47	R\$ 102.921,38	R\$-	-R\$ 1.621,11
3	R\$ 1.491.510,36	R\$ 124.402,64	R\$-	-R\$ 1.694,06
4	R\$ 1.813.613,29	R\$ 150.367,38	R\$-	-R\$ 1.770,29
5	R\$ 2.205.270,75	R\$ 181.751,35	R\$-	-R\$ 1.849,95
6	R\$ 2.681.501,03	R\$ 219.685,64	R\$-	-R\$ 1.933,20

With the support of Table 12, the analysis of the cumulative cash flow for the investment in the photovoltaic system was conducted. From this evaluation, it was observed that the return on investment of the system was projected to occur at the beginning of the third year of operation, considering the start of energy generation in the building. This projection demonstrates the economic viability of the project, indicating that financial benefits will begin to be obtained within a relatively short period. Monitoring the cumulative cash flow provides a clear view of the financial return over time, assisting in the analysis and decision-making

regarding the investment in the photovoltaic system. This favorable perspective reinforces the attractiveness of the project and encourages the implementation of sustainable energy generation solutions.

TABLE XII  
COST EVALUATION AND RETURN ON INVESTMENT

Year	Annual Cash Flow	Cumulative Cash Flow
-	[R\$]	[R\$]
0	-R\$ 310.259,88	-R\$ 310.259,88
1	R\$ 83.598,09	-R\$ 226.661,79
2	R\$ 101.300,27	-R\$ 125.361,52
3	R\$ 122.708,58	-R\$ 2.652,94
4	R\$ 148.597,09	R\$ 145.944,15
5	R\$ 179.901,39	R\$ 325.845,54
6	R\$ 217.752,43	R\$ 543.597,98

In Figure 29, it was possible to visualize the previously mentioned break-even point of the investment. This graphical representation clearly shows the period in which the financial benefits of investing in the photovoltaic system start to outweigh the initial costs. The break-even point marks the moment when the cumulative value of benefits reaches the cumulative value of costs, indicating the recovery of the investment made. This figure provides a visually impactful and concise representation of the project's payback, aiding in understanding the financial viability of implementing the photovoltaic system.

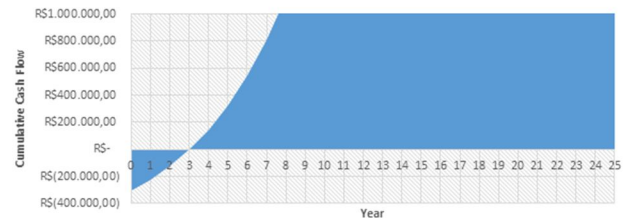


Fig. 29. Payback plot

The payback presented in the analysis of the photovoltaic system brings positive points that contribute to the economic viability of the investment. Firstly, the fact that the return on investment was projected to occur at the beginning of the third year of operation demonstrates that the system has significant potential for financial return.

A relatively short payback period is advantageous as it allows the investor to recover the invested capital within a reasonably short timeframe. This means that after the payback period, financial benefits start to be obtained, increasing the profitability of the investment. Additionally, a quick payback period also reduces financial risk as there is less time for potential market variations or changes in energy tariff policies to occur.

In addition to evaluating the costs of conventional photovoltaic systems, exploration of innovative energy generation technologies was also pursued. However, due to their highly advanced nature and the unavailability of known suppliers for these technologies, it was impossible to conduct a detailed cost analysis. Although costs were



not verified, an analysis was made regarding the incorporation of new generation sources by understanding the need for adaptation to trends and the development of technologies, as they can play a crucial role in transitioning to a more sustainable energy future.

Considering the search for innovative energy generation alternatives, specific assessments were conducted for the concept of BIPV (Building Integrated Photovoltaics), which involves integrating photovoltaic elements directly into building surfaces. This approach allows the building structures themselves to act as energy generators, leveraging the potential of surfaces such as facades, windows, and roofs. However, the potential of these integrated solutions, which combine architectural functionality with sustainable energy generation, is emphasized, contributing to building energy efficiency and reducing dependence on traditional energy sources.

Within the simulations conducted in the Design Builder software, windows with the potential for photovoltaic generation using special glass were considered. These glasses have photovoltaic properties that enable the conversion of sunlight into electricity. The simulation results revealed that over the evaluated period, a total of 16.16 MWh of energy was generated through the photovoltaic windows. However, it is important to highlight that there was a waste of 646.57 kWh during the conversion process in the equipment. This analysis allows for understanding the potential of energy generation from windows with special glass, as well as the need to improve the efficiency of the equipment involved in the solar energy conversion.

The use of windows with special glass for photovoltaic generation presents some challenges, such as high costs and lower efficiency compared to other more conventional photovoltaic technologies. These windows have a high cost due to their complex manufacturing process and the special materials used. Additionally, the efficiency of these devices is generally lower than that of traditional photovoltaic systems due to technical limitations and the smaller available area for capturing sunlight [30].

## V. CONCLUSION

As a result of the evaluations conducted, it was found that incorporating energy efficiency actions focused on optimizing the use of electricity is possible. The various variables included in the consumption analysis, whether human, climatic, or construction-related, can be targeted for actions that develop usage patterns with more sustainable expectations and offer buildings with more suitable performance in a world with increasingly scarce energy.

The analysis showed how different climatic parameters such as air temperature, relative humidity, wind speed, and precipitation affect the dynamic behavior of a

building. The use of these climatic variables can provide better support for energy efficiency projects that will be developed. Additionally, it was observed that technologically suitable materials for specific regional characteristics can enhance building performance.

Another satisfactory finding was the convergence of microclimate data from a building with national measurements of a city when used as parameters for building efficiency projects. This possibility allows for greater agility in working with information related to the project's climatic characteristics.

It was also concluded that planning and organizing information play a fundamental role in achieving satisfactory results in an energy efficiency project. The presented real-life case demonstrated how collecting and correctly dimensioning study parameters, such as environmental characteristics, occupancy and building usage, operating systems and equipment, were essential for the development of a successful project. The elaboration of a detailed project, considering all the collected information, proved crucial for implementing efficient strategies and selecting the most appropriate technologies. In short, careful consideration and in-depth analysis of study parameters are essential to ensure the effectiveness and success of an energy efficiency project that takes calculated and simulated values into account.

The evaluation of the influence of energy efficiency actions linked to material choices in the project, such as window glasses and generation equipment, revealed the importance of these decisions in reducing electricity consumption. By considering materials with specific properties, such as innovative window glasses with energy generation capabilities and efficient photovoltaic generation equipment, significant benefits in terms of energy efficiency could be achieved. Through the proper selection of these materials, it was possible to assess performance losses and gains resulting from greater utilization of solar energy, contributing to the reduction of energy consumption and associated costs. These choices demonstrate that energy efficiency actions can be incorporated from the early stages of a project, providing benefits from both an economic and environmental standpoint.

The proposal of actions aimed at building efficiency based on the evaluated local climatic characteristics proved to be important. By analyzing the specific climatic conditions of the region, effective strategies for reducing electricity consumption and improving the building's thermal performance could be identified. An example of this is the use of sunshades and window films, architectural elements employed to protect indoor spaces from direct sunlight, minimizing heat gain and reducing the need for artificial cooling.

Therefore, based on the considerations made, it was possible to envision new guidelines for future work that expands and deepens studies related to building

efficiency. Among these guidelines, the consideration of new input variables to verify the compatibility of materials to be used in the building envelope stands out, allowing for the selection of more efficient and suitable solutions.

Additionally, conducting more in-depth actions based on local airflow patterns and exploring natural ventilation strategies to optimize thermal comfort and reduce the need for air conditioning systems is suggested.

The monitoring of buildings that have undergone efficiency processes is also a promising approach, enabling the evaluation of the actual performance of the implemented interventions and identifying opportunities for continuous improvement.

For more accurate simulations, it is recommended to use methodologies that consider the building envelope as a whole, considering factors such as thermal insulation, solar orientation, and shading.

Finally, creating a scope of actions for reeducation and proper use of electricity that incorporates clear explanations of the benefits and reasons for including energy efficiency projects can contribute to user engagement and awareness, promoting a culture of responsible energy use. These directions pave the way for further research and practices aimed at further enhancing energy efficiency in buildings.

#### REFERENCES

- [1] ONU, "Sustainable Development Goal 11: Cidades e comunidades sustentáveis," 2015. <https://brasil.un.org/pt-br/sdgs/11> (accessed Jan. 23, 2023).
- [2] A. Athienitis and W. O'Brien, "Net ZEB Design processes and tools," in *Modeling, Design and Optimization of Net-Zero Energy Buildings*, 1st ed. Wiley, 2015, pp. 107–133.
- [3] E. P. dos Santos, "Mercado no Brasil para uso de energias renováveis e ações de eficiência energética," Universidade de São Paulo, São Paulo, 2020. doi: 10.11606/D.85.2020.tde-02102020-154629.
- [4] S. R. Sarra, "Desempenho de edifícios comerciais representativos da arquitetura modernista em São Paulo: avaliação do Edifício Itália com enfoque em ergonomia," Universidade de São Paulo, São Paulo, 2019. doi: 10.11606/D.16.2019.tde-07012019-143531.
- [5] ANEEL, "Relatório de Consumo e Receita de Energia," 2020. [http://relatorios.aneel.gov.br/\\_layouts/xlviewer.aspx?id=/RelatoriosSAS/RelSAMPCLasseConsNivel.xlsx&Source=http%3A%2F%2Frelatorios%2Eaneel%2Egov%2Ebr%2FRelatoriosSAS%2FForms%2FAllItems%2Easpx&DefaultItemOpen=1](http://relatorios.aneel.gov.br/_layouts/xlviewer.aspx?id=/RelatoriosSAS/RelSAMPCLasseConsNivel.xlsx&Source=http%3A%2F%2Frelatorios%2Eaneel%2Egov%2Ebr%2FRelatoriosSAS%2FForms%2FAllItems%2Easpx&DefaultItemOpen=1) (accessed Jan. 23, 2023).
- [6] J. C. S. Gonçalves, "O novo ambiente de trabalho: diversidade ambiental e flexibilidade do espaço," *Pós. Revista do Programa de Pós-Graduação em Arquitetura e Urbanismo da FAUUSP*, vol. 26, no. 49, p. e161676, Dec. 2019, doi: 10.11606/issn.2317-2762.posfau.2019.161676.
- [7] R. Emmanuel, *Urban Climate Challenges in the Tropics*. IMPERIAL COLLEGE PRESS, 2016. doi: 10.1142/p1048.
- [8] E. Ghisi, J. A. Tinker, and S. H. Ibrahim, "Área de janela e dimensões de ambientes para iluminação natural e eficiência energética: literatura versus simulação computacional," *Ambiente Construído*, vol. 5, no. 4, Apr. 2005.
- [9] L. K. Yew, "The East Asian Way-With Air Conditioning," *New Perspectives Quarterly*, vol. 26, no. 4, pp. 111–120, Sep. 2009, doi: 10.1111/j.1540-5842.2009.01120.x.
- [10] P. S. Scarazzato, "Questões de luz na formação do arquiteto.," Universidade de São Paulo, São Paulo, 2019. doi: 10.11606/T.16.2019.tde-04112019-163717.
- [11] R. C. Torres, "Energia solar fotovoltaica como fonte alternativa de geração de energia elétrica em edificações residenciais," Universidade de São Paulo, São Carlos, 2012. doi: 10.11606/D.18.2012.tde-18032013-091511.
- [12] Brasil, Lei no 9.991. Brasília, 2000.
- [13] INMETRO, Portaria n.o 372. Rio Comprido/RJ, 2010.
- [14] ANEEL, Guia prático de chamadas públicas do PEE para proponentes. 2016.
- [15] R. H. Mokwa, "Análise da execução de ações de eficiência energética nas instalações elétricas da sede centro da UTFPR em Curitiba," Universidade Tecnológica Federal do Paraná, Curitiba, 2021.
- [16] K. Chaloeitoy, V. Inkarojrit, and A. Thanachareonkit, "Electricity Consumption in Higher Education Buildings in Thailand during the COVID-19 Pandemic," *Buildings*, vol. 12, no. 10, p. 1532, Sep. 2022, doi: 10.3390/buildings12101532.
- [17] Y. Su, H. Cheng, Z. Wang, and L. Wang, "Impacts of the COVID-19 lockdown on building energy consumption and indoor environment: A case study in Dalian, China," *Energy Build*, vol. 263, p. 112055, May 2022, doi: 10.1016/j.enbuild.2022.112055.
- [18] ANEEL, Programa de Eficiência Energética - PROPEE. Resolução Normativa, 2020.
- [19] P. C. Schwalm, "Ações De Uso Eficiente E Racional De Energia Elétrica Baseadas No PEE Da Aneel Através De Modelagem Energética – Um Estudo De Caso," UFRS, Tramandaí, 2021.

- [20] M. A. Triana and R. Lamberts, "PROPOSTA DE INCORPORAÇÃO DE ESTRATÉGIAS PARA MELHORIA DE DESEMPENHO TÉRMICO E USO RACIONAL DE ENERGIA EM PROJETO DE HABITAÇÃO DE INTERESSE SOCIAL EM FLORIANÓPOLIS," in XII ENCAC Encontro Nacional de Conforto no Ambiente Construído, 2013.
- [21] J. Carlo and R. Lamberts, "Parâmetros e métodos adotados no regulamento de etiquetagem da eficiência energética de edifícios-parte 1: método prescritivo," Edição Especial Conforto Ambiental e Eficiência, vol. 10, no. 2, pp. 7–26, 2010, Accessed: Jan. 22, 2023. [Online]. Available: <https://seer.ufrgs.br/index.php/ambienteconstruido/article/view/11790>
- [22] R. Venâncio, "Modos projetuais de simulação: Uso de ferramentas de simulação térmica no processo projetual de arquitetura,," Universidade Federal do Rio Grande do Norte, Natal, 2012.
- [23] E. Gabriel, "ANÁLISE DO DESEMPENHO DE SISTEMAS DE ILUMINAÇÃO LATERAL EM EDIFÍCIOS COMERCIAIS NA ZONA BIOCLIMÁTICA 2," UFSM, Santa Maria, 2020.
- [24] M. Keeler and B. Burke, "A história dos movimentos ambientalistas," in Projeto de edificações sustentáveis, 1st ed. Bookman, 2010, pp. 28–39.
- [25] A. G. Kwok and W. T. Grondzik, "O processo de Projeto," in Manual de Arquitetura Ecológica, 1st ed. Porto Alegre: Bookman, 2010, pp. 11–22.
- [26] E. H. Borgstein, R. Lamberts, and J. L. M. Hensen, "Evaluating energy performance in non-domestic buildings: A review," Energy Build, vol. 128, pp. 734–755, Sep. 2016, doi: 10.1016/j.enbuild.2016.07.018.
- [27] NASA, "What's the Difference Between Weather and Climate? | NASA," 2005. [https://www.nasa.gov/mission\\_pages/noaa-n/climate/climate\\_weather.html](https://www.nasa.gov/mission_pages/noaa-n/climate/climate_weather.html) (accessed Feb. 13, 2023).
- [28] L. M. B. Castelo Branco, "Microclimas urbanos no Plano Piloto de Brasília: o caso da Superquadra 108 Sul," Dissertação, Universidade de Brasília, Brasília, 2009.
- [29] C. T. Machado and F. S. Miranda, "Photovoltaic Solar Energy: A Briefly Review," Revista Virtual de Química, vol. 7, no. 1, 2015, doi: 10.5935/1984-6835.20150008.
- [30] A. H. C. dos Santos, "Avaliação técnica e financeira da geração fotovoltaica integrada à fachada de edifícios de escritórios corporativos na cidade de São Paulo," Universidade de São Paulo, São Paulo, 2016. doi: 10.11606/T.106.2016.tde-12022016-101152.
- [31] M. V. SANTANA, "Influência de Parâmetros Construtivos no Consumo de Energia de Edifícios de Escritório Localizados em Florianópolis – SC," UFSC, Florianópolis, 2006.
- [32] CEMIG, "POTÊNCIA MÉDIA DE APARELHOS RESIDENCIAIS E COMERCIAIS," 2022. <https://www.cemig.com.br/wp-content/uploads/2020/10/POTENCIA-MEDIA-DE-APARELHOS-RESIDENCIAIS-E-COMERCIAIS.pdf> (accessed Jan. 19, 2023).
- [33] E. H. Borgstein, R. Lamberts, and J. L. M. Hensen, "Mapping failures in energy and environmental performance of buildings," Energy Build, vol. 158, pp. 476–485, Jan. 2018, doi: 10.1016/j.enbuild.2017.10.038.
- [34] A. Felipe Oliveira Lopes, "Da simulação ao projeto: avaliação de conforto térmico em ambiente escolar padronizado,," 2020.
- [35] E. L. Didoné, A. Wagner, and F. O. R. Pereira, "Estratégias para edifícios de escritórios energia zero no Brasil com ênfase em BIPV," Ambiente Construído, vol. 14, no. 3, pp. 27–42, 2014.
- [36] K. S. Srivishnu, P. R. Markapudi, S. Sundaram, and L. Giribabu, "Semitransparent Perovskite Solar Cells for Building Integrated Photovoltaics: Recent Advances," Energies (Basel), vol. 16, no. 2, p. 889, Jan. 2023, doi: 10.3390/en16020889.
- [37] Aneel, "Tarifas residências efeitos dos reajustes tarifários," Mar. 22, 2023. <https://app.powerbi.com/view?r=eyJrIjoiZDFmMzIzM2QtM2EyNi00YjkyLWlxdmYtYTU4NTI0NTI1IiwidCI6IjQwZDZmOWI4LWVjYjYtNDZhMi05MmQ0LWVhNGU5YzAxNzBIMSIsImMiOjR9> (accessed Mar. 21, 2023).
- [38] JA Solar, "Datasheet Deepblue 3.0," Module JA SOLAR JAM72S30-550/MR. 2023.
- [39] Ministério da Saúde, "Ministério da Saúde regulamenta medidas de isolamento e quarentena," Mar. 12, 2020. <https://www.gov.br/pt-br/noticias/saude-e-vigilancia-sanitaria/2020/03/ministerio-da-saude-regulamenta-medidas-de-isolamento-e-quarentena> (accessed Feb. 05, 2023).
- [40] H. Rong, H. Zhang, S. Xiao, C. Li, and C. Hu, "Optimizing energy consumption for data centers," Renewable and Sustainable Energy Reviews, vol. 58, pp. 674–691, May 2016, doi: 10.1016/j.rser.2015.12.283.
- [41] X. Shao, Z. Zhang, P. Song, Y. Feng, and X. Wang, "A review of energy efficiency evaluation metrics for data centers," Energy Build, vol. 271, p. 112308, Sep. 2022, doi: 10.1016/j.enbuild.2022.112308.



- [42] J. C. Lam, C. L. Tsang, and L. Yang, "Impacts of lighting density on heating and cooling loads in different climates in China," *Energy Convers Manag*, vol. 47, no. 13–14, pp. 1942–1953, Aug. 2006, doi: 10.1016/j.enconman.2005.09.008.
- [43] INMET, "Banco de Dados Meteorológicos (BDMEP)," 2023. <https://bdmep.inmet.gov.br/> (accessed Feb. 05, 2023).
- [44] C. F. e Silva, M. A. B. Romero, D. A. Muñoz Arboleda, J. T. Fernandes, J. C. Guillén-salas, and G. D. B. Sousa, "Parametrização Bioclimática: disposição dos elementos ambientais no espaço público da escala intra-urbana. O Setor Bancário Norte, Brasília - DF," *Paranoá: cadernos de arquitetura e urbanismo*, no. 5, Dec. 2010, doi: 10.18830/issn.1679-0944.n5.2010.15485.
- [45] D. R. WERNECK, "ESTRATÉGIAS DE MITIGAÇÃO DAS ILHAS DE CALOR URBANAS: ESTUDO DE CASO EM ÁREAS COMERCIAIS EM BRASÍLIA - DF.," Dissertação, UNIVERSIDADE DE BRASÍLIA, Brasília, 2018.
- [46] G. G. Souza, R. R. Santos, and E. F. Saraiva, "Sistema de Hardware/Software para Estimativas de Perdas de Geração em Usinas Solares Fotovoltaicas," in *Anais do XLVIII Seminário Integrado de Software e Hardware (SEMISH 2021)*, Sociedade Brasileira de Computação - SBC, Jul. 2021, pp. 214–224. doi: 10.5753/semish.2021.15825.
- [47] L. V. Abreu and L. C. Labaki, "Conforto térmico propiciado por algumas espécies arbóreas: avaliação do raio de influência através de diferentes índices de conforto," *Ambiente Construído*, vol. 10, no. 4, pp. 103–117, Dec. 2010, doi: 10.1590/S1678-86212010000400008.
- [48] O. H. Ando Junior and C. Becerra-Díaz, "Investigation of the effect temperature on the performance of the photovoltaic solar design for the western Region of Paraná - Brazil," *Dyna (Medellin)*, vol. 88, no. 217, pp. 185–199, May 2021, doi: 10.15446/dyna.v88n217.91140.
- [49] A. Bamasag et al., "Recent advances and future prospects in direct solar desalination systems using membrane distillation technology," *J Clean Prod*, vol. 385, p. 135737, Jan. 2023, doi: 10.1016/j.jclepro.2022.135737.